

Raynor Innovations Series™

THE ULTIMATE IN DESIGN CHOICES



9' x 8' and 18' x 8' Relante Colonial in White

For reliability, Raynor Relante is the perfect choice. With many of the features and qualities that today's homeowners are looking for, Relante doors offer a great look at a great value. Relante doors are available in 3 standard door designs: colonial, ranch, and flush.



1 3/8" Thick Sections

Relante's 1 3/8" thick door sections are made from strong, rust-resistant, 24-gauge embossed galvanized steel and are coated with a baked-on polyester paint finish for long life.

- 1 Baked-on finish
- 2 Epoxy primer
- 3 Galvanized layer
- 4 High-strength steel
- 5 Polyurethane insulation
- 6 High-strength steel

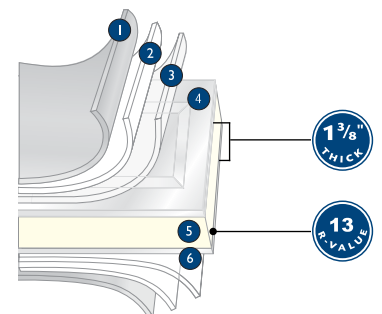

SECTIONS WARRANTED "FOR AS LONG AS YOU OWN YOUR HOME" AGAINST RUST
 HARDWARE/SPRINGS: 3 YEARS

Hardware



Relante doors feature galvanized steel track and steel wheel, ball bearing rollers for smooth, reliable operation.

Insulation



Our innovative process fills 100% of the door's interior space. The energy-saving polyurethane core delivers an exceptional **13 R-value** and helps to reduce noise.

Finger Protection



As your door closes, the exclusive Raynor Finger Protection System™ gently pushes fingers away from section joints.

Colors



White



ClayTone

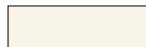

Almond

Hurricane Reinforcing Systems



Relante single car doors and double-car doors with lower pressure requirements incorporate high-strength steel U-bar reinforcement, for a Hurricane-Ready™ design.

No Tools Required! 1. Relante double-car doors requiring higher pressures use a Removable Hurricane Post system to protect your home against hurricane-force winds. Installation is easy - no tools are required. When the time comes to ready your door, simply place the post(s) into position. (Posts should be stored near the door on the garage wall for convenient access.) 2. Slip header latch into position; 3. Place straps around post and secure with cotter pin. 4. Drop pin into floor. In a matter of minutes, your home will be protected from hurricane-velocity winds.

Sizes

Heights:

6'-0", 6'-3", 6'-6", 6'-9", 7'-0", 7'-6", 7'-9", 8'-0"

Widths: 6'-0" - 18'-0"

Panel Styles

Standard Designs*

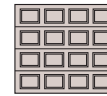

Colonial 1-car

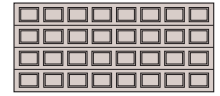

Colonial 2-car

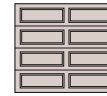

Ranch 1-car

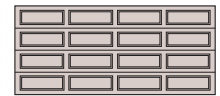

Ranch 2-car

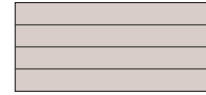

Flush 1-car or 2-car

*1-car doors shown in 8' x 7' configuration.
 2-car doors shown in 16' x 7' configuration.

Windload Details

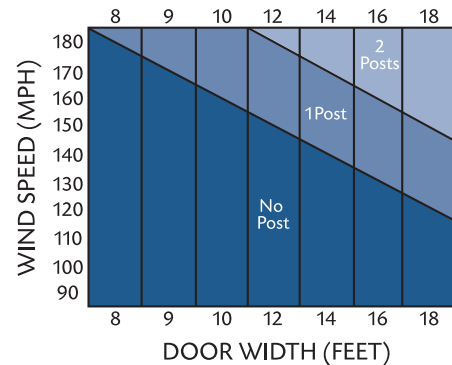

Chart represents approximate design requirements. Contact your Raynor dealer for exact pressures and designs.

Raynor Worldwide
 P.O. Box 448, 1101 East River Road
 Dixon, IL 61021-0448

www.raynor.com
 1-800-4-RAYNOR (472-9667)