

RELANTE™

Raynor Innovations Series™

SECTIONAL GARAGE DOORS

STANDARD ♦ 3-LAYER CONSTRUCTION
STEEL • INSULATION • STEEL



3048mm x 2125mm
Relante Flush in White

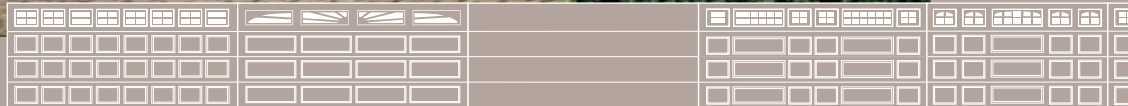

TESTED TO MEET THE
LATEST EUROPEAN STANDARDS



RELANTE™

For reliability, the Relnate door is the perfect choice.

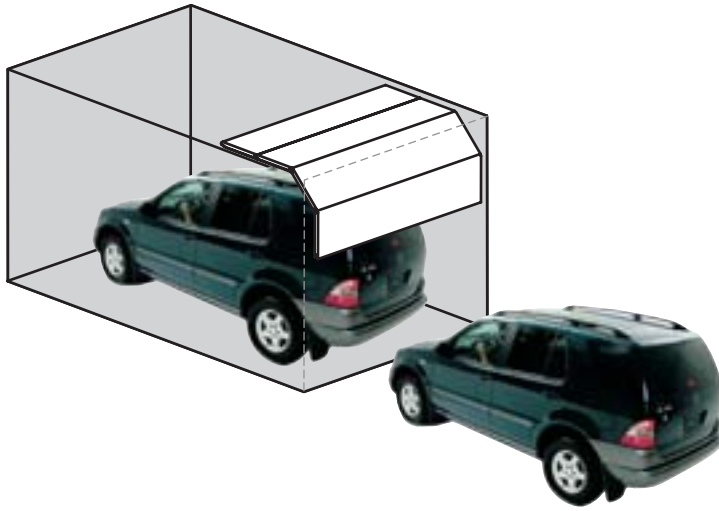

Sectional garage doors make full use of your garage's available space. Outside, they allow for close parking. Inside, the door is raised up and over the garage interior, allowing for complete use of available space and access for today's taller vehicles.



36 mm Thick Sections

Relante's 35mm thick door sections are made from strong, corrosion-resistant, .43mm embossed galvanized steel skins and are coated with a baked-on polyester paint finish for long life.

- ① Baked-on finish
- ② Epoxy primer
- ③ Galvanized layer
- ④ High-strength steel
- ⑤ Polyurethane insulation
- ⑥ High-strength steel

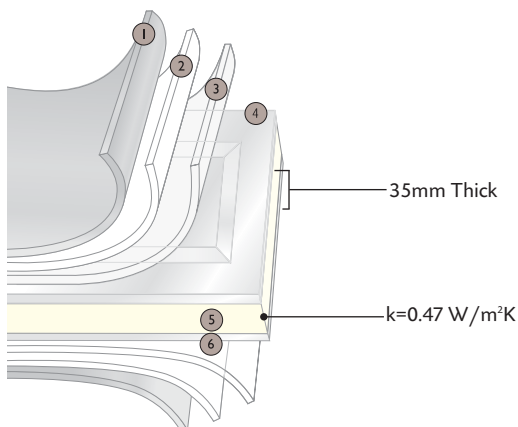

Colors

Standard

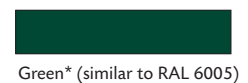
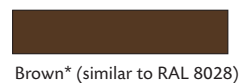
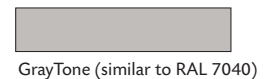
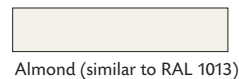
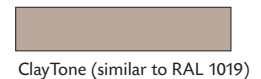
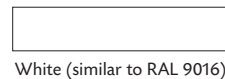

Contact your Raynor Dealer for availability of additional colors.

*Features a fluorocarbon pvf2 paint process, which provides extended UV protection against fading.



2438mm x 2125mm Relante Colonial in Brown

35mm	0.47W/m ² K
THICK	K

Hardware



Nylon rollers with steel ball bearings provide smooth operation and superior noise reduction. Relante doors feature galvanized steel track.

Standard Warranty

Door Sections: 10 Years

Hardware/Springs: 3 Years

RELANTE™

Performance & Durability

1 Quiet Operation



Nylon rollers with steel ball bearings provide smooth operation and superior noise reduction - a plus when living space is in close proximity to the garage. Hinges, made of high-quality steel, feature an attractive low-profile design

and are powdercoated white to provide maximum protection against corrosion.

2 Custom-Fit Track



Track is fully adjustable for fast installation and for a tight fit against the door opening, preventing energy loss.

3 Energy Saving Insulation



Energy-saving CFC-free polyurethane insulation completely fills the door's interior space for maximum structural integrity and exceptional energy savings: $k=0.47 \text{ W/m}^2\text{K}$ for door sections, $k=1.01 \text{ W/m}^2\text{K}$ for installed door.

4 Thermal Protection

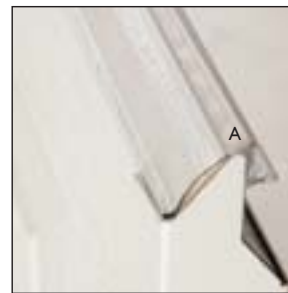

Thermal protection, provided by a continuous thermal break (A), prevents heat loss and metal-to-metal contact between inside and outside surfaces.

5 Long-Lasting Springs



EnduraCote springs are powdercoated black for corrosion resistance and longer life. Springs are designed to precisely counterbalance each door's weight for effortless opening and closing.

6 Effective Weatherseal



Durable rubber perimeter weatheseal along the top, sides and bottom help keep out wind, rain and snow while reducing air infiltration.



Safety

7 Finger Protection



As your door opens and closes, the Raynor Finger Protection System prevents finger entrapment both inside and outside by gently keeping fingers away from section joints.

8 Cable Attachment Protection



Safety attachment for lifting cables helps prevent accidents and injuries. Lifting cable attachment cannot be released while the cable is under tension.

9 Hand Protection



Side hand guard completely encloses the frames to prevent accidental entrapment along either side. Lifting cable always remain behind guard.

10 Spring Break Protection



Spring break safety device prevents the door from dropping more than 300mm in the event of counterbalance failure.

Options & Decorative Windows

Locks



Optional lock for manually-operated doors is fitted with "Euronorm" cylinder.

Restricted Headroom



For restricted head-room situations, counterbalance is mounted at the end of the horizontal track.

Decorative Windows

THE ULTIMATE IN ELEGANCE

Dimensions™

Acrylic Leaded & Beveled



Antique Charcoal Ranch



Antique Brass Ranch



Regency Brass Colonial



Expression Brass Colonial

Snap-In Styles



Sunburst Colonial



Sunburst Ranch



Stockton Colonial



Stockton Ranch



Cascade Colonial



Cascade Ranch



Sherwood Colonial



Cathedral Colonial



Sunray Ranch

Note: Windows are shown in single configuration, with the exception of Sunray Ranch.

Silkscreen Styles



Sherwood Colonial



Cathedral Colonial



Sunburst Ranch

Clear and Obscure

Clear Tempered Glass



Colonial

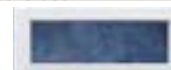

Ranch

Obscure Tempered Glass



Colonial



Ranch

Door Designs

ELEVATIONS AND SIZES

Colonial



1829mm - 2134mm Height
1829mm - 2108mm Width

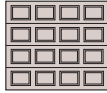

1829mm - 2134mm Height
2125mm - 3124mm Width

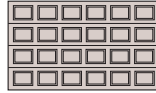

1829mm - 2134mm Height
3150mm - 4114mm Width

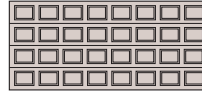

1829mm - 2134mm Height
4140mm - 5918mm Width

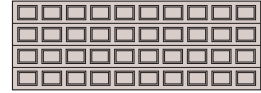

1829mm - 2134mm Height
5944mm - 6096mm Width



2286mm - 2667mm Height
1829mm - 2108mm Width

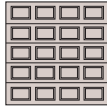

2286mm - 2667mm Height
2125mm - 3124mm Width

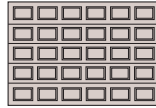

2286mm - 2667mm Height
3150mm - 4114mm Width

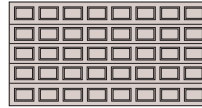

2286mm - 2667mm Height
4140mm - 5918mm Width

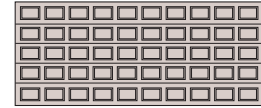

2286mm - 2667mm Height
5944mm - 6096mm Width

Ranch



1829mm - 2134mm Height
2125mm - 2108mm Width

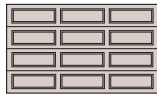

1829mm - 2134mm Height
3150mm - 4114mm Width

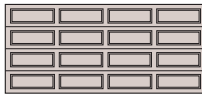

1829mm - 2134mm Height
4140mm - 5918mm Width

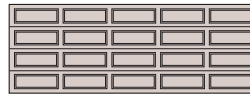

1829mm - 2134mm Height
5944mm - 6096mm Width



2286mm - 2667mm Height
2125mm - 3124mm Width



2286mm - 2667mm Height
3150mm - 4114mm Width



2286mm - 2667mm Height
4140mm - 5918mm Width



2286mm - 2667mm Height
5944mm - 6096mm Width

Flush

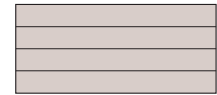

1829mm - 2134mm Height
1829mm - 6096mm Width

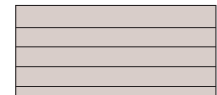

2286mm - 2667mm Height
1829mm - 6096mm Width

MIXED PANELS

Millcreek

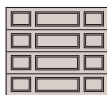

1829mm - 2134mm Height
2125mm - 3124mm Width



2286mm - 2667mm Height
2125mm - 3124mm Width

Bridgeport

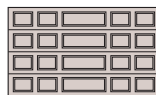

1829mm - 2134mm Height
3150mm - 4114mm Width



2286mm - 2667mm Height
3150mm - 4114mm Width

Ridgelake



1829mm - 2134mm Height
3150mm - 4114mm Width



2286mm - 2667mm Height
3150mm - 4114mm Width

Baypoint

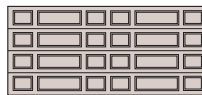

1829mm - 2134mm Height
4140mm - 5918mm Width

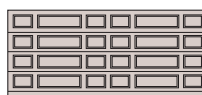

2286mm - 2667mm Height
4140mm - 5918mm Width

Highcrest



1829mm - 2134mm Height
4140mm - 5918mm Width



2286mm - 2667mm Height
4140mm - 5918mm Ancho

Fitting Drawings

FOR GARAGE DOORS

JAMB DETAIL

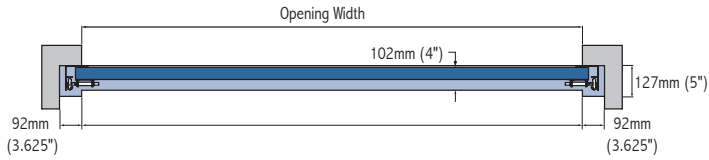

STANDARD HEADROOM ELEVATION

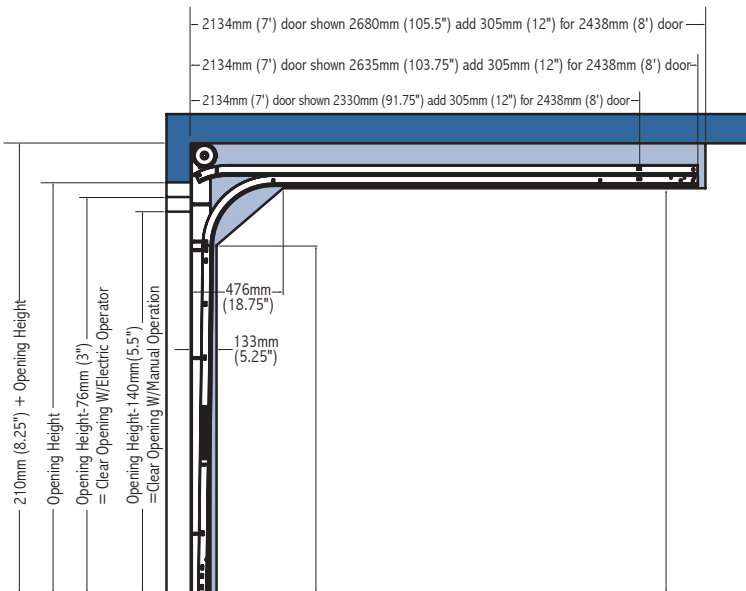

RESTRICTED HEADROOM ELEVATION

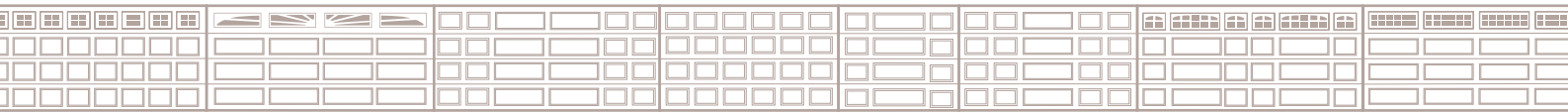
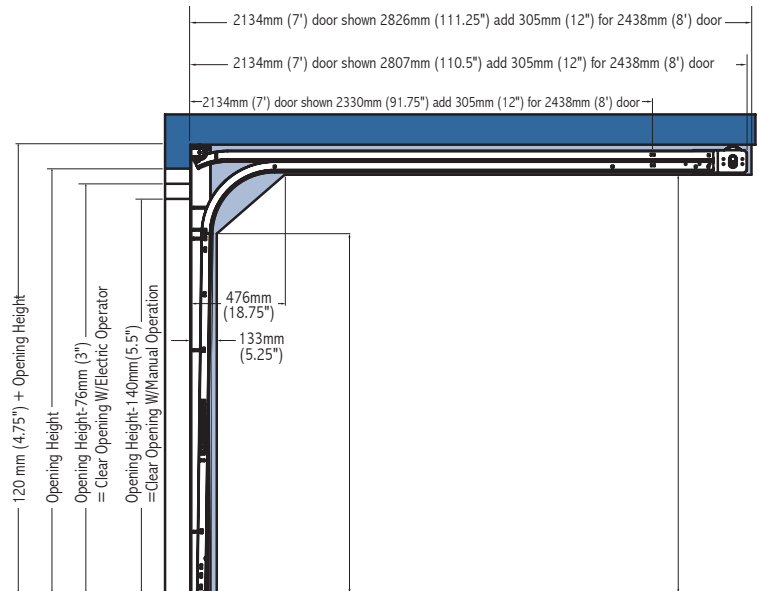

www.raynor.com

Raynor Worldwide • P.O. Box 448, 1101 East River Road • Dixon, IL 61021-0448 USA



This information was as complete and factual as possible at the time it was printed. We do, however, reserve the right to make product changes in specifications and availability without notice. Product colors have been reproduced as well as possible with present commercial printing processes. For absolute accuracy in color matching, use actual product samples.

Features and options may vary.