

DOOR NUMBER	QTY	OPENING		MODEL	GA.	"A"	"B"	"C"	"D"	"E"	"F"	"G"	"H"	"J"	MOUNT TYPE	OPER.	DRIVE	JAMB TYPE	GUIDE	JOB:	
		WIDTH	HEIGHT																		
																				DISTRIBUTOR:	 RAYNOR
																				CONTRACTOR:	
																				ARCHITECT:	

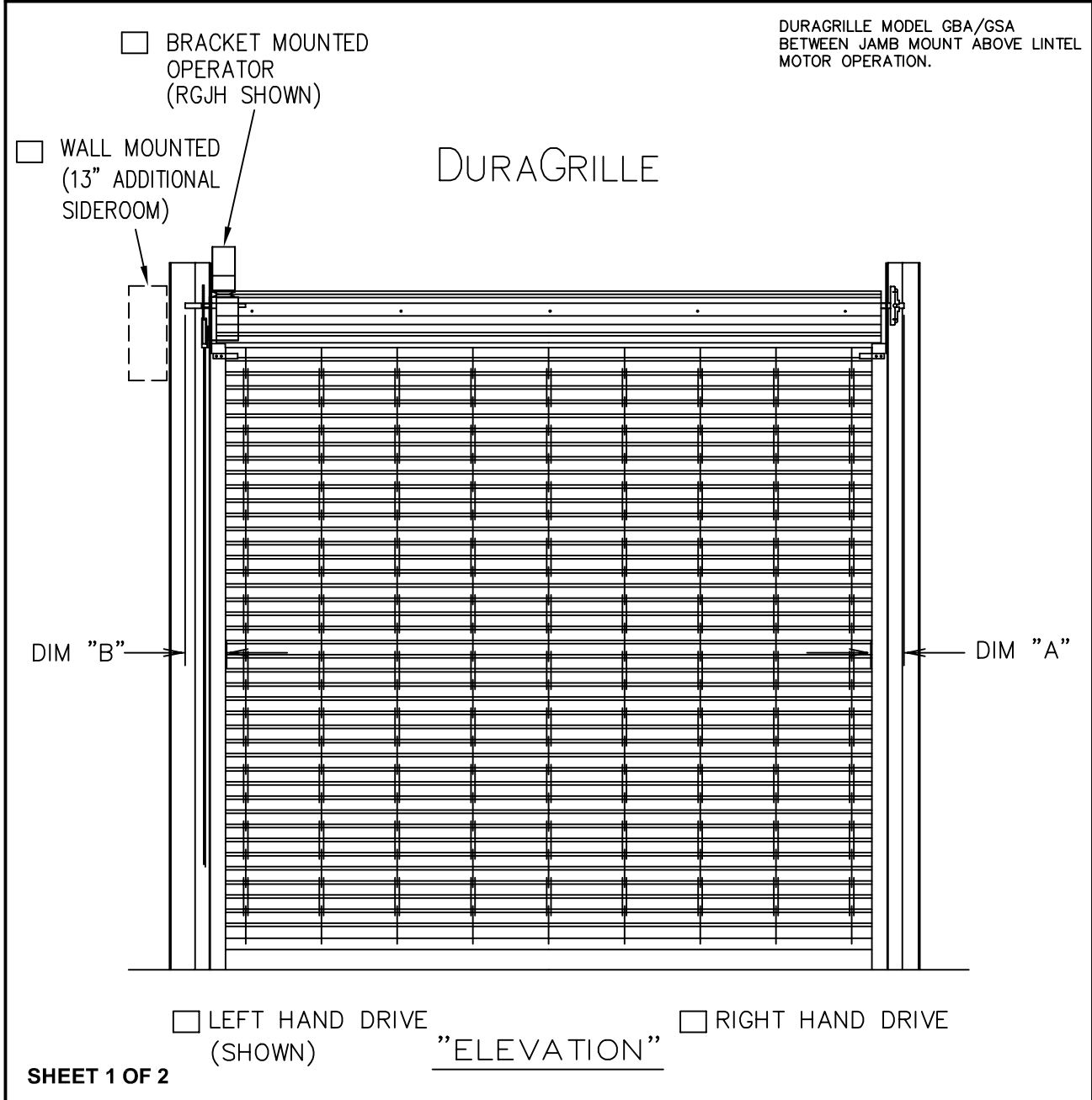

DURAGRILLE MODEL GBA/GSA BETWEEN JAMB MOUNT ABOVE LINTEL MOTOR OPERATION.

- DOORS SHALL BE ROLLING STEEL MODEL DURAGRILLE "STANDARD" (GRILLE DOORS) AS MANUFACTURED BY RAYNOR GARAGE DOORS.
- BRACKETS— STEEL PLATES, MIN. 3/16"(4.8mm) THICK, BOLTED TO GUIDES FOR MOUNTING CURTAIN AND BARREL ASSEMBLY. DRIVE SIDE BRACKET SHALL BE FITTED WITH A SEALED BALL BEARING FOR LONG LIFE.
- BARREL— STRUCTURAL STEEL PIPE, MINIMUM 4-1/2"(114.3mm) O.D.x.120" (3.0mm) WALL THICKNESS AND DESIGNED TO LIMIT MAXIMUM DEFLECTION, UNDER LOAD, TO .03"(0.76mm) PER FOOT OF SPAN.
- SPRING COUNTERBALANCE— THE CURTAIN SHALL BE COUNTERBALANCED BY MEANS OF OIL TEMPERED, HELICAL TORSION SPRINGS, GREASE-PACKED AND MOUNTED ON A SINGLE CONTINUOUS STEEL TORSION SHAFT. SPRINGS SHALL BE COMPRESSION SPRING DESIGN TO FACILITATE ANY COUNTERBALANCE MAINTENANCE. CAST IRON SPRING ANCHORS SHALL TRANSFER FULL SPRING LOADING TO THE BARREL.
- GUIDES— SHALL CONSIST OF EXTRUDED ALUMINUM (6063-T5) WITH WOOL PILE INSERTS TO REDUCE NOISE. THE EXTRUDED ALUMINUM GUIDES WILL BE ATTACHED TO EITHER STRUCTURAL STEEL ANGLES, OR STRUCTURAL STEEL SUPPORT TUBES, OR DIRECTLY TO THE JAMBS DEPENDING ON THE REQUIREMENTS.
- MODEL GSA**
- CURTAIN— CONSISTS OF HORIZONTAL 5/16" (7.9mm) DIAMETER ALUMINUM RODS SPACED VERTICALLY @ 2" (50.8mm) O.C. AND THE LINKS SPACED HORIZONTALLY @ 9" (228.9mm) O.C. THE BOTTOM OF THE CURTAIN TO BE REINFORCED WITH AN ALUMINUM EXTRUDED TUBULAR BOTTOM BAR.
- MODEL GBA**
- CURTAIN— CONSISTS OF HORIZONTAL 5/16" (7.9mm) DIAMETER ALUMINUM RODS SPACED VERTICALLY @ 2" (50.8mm) O.C. AND THE LINKS SPACED HORIZONTALLY @ 9" (228.9mm) O.C. IN A BRICK PATTERN. THE BOTTOM OF THE CURTAIN TO BE REINFORCED WITH AN ALUMINUM EXTRUDED TUBULAR BOTTOM BAR.
- HOOD—OMIT
- HOOD—SHALL BE 24 GA. COMMERCIAL QUALITY HOT-DIPPED GALVANIZED STEEL WITH ROLLED EDGES TO PROVIDE STRUCTURAL RIGIDTY.
- HOOD—SHALL BE ALUMINUM .04 (1mm) THCK WITH ROLLED EDGES TO PROVIDE STRUCTURAL RIGIDTY.
- FINISH— ALUMINUM CURTAIN, BOTTOM BAR, & GUIDES TO BE BRONZE ANODIZED.
- FINISH— ALUMINUM CURTAIN TO BE MILLED. GUIDES & BOTTOM BAR CLEAR ANODIZED.
- FINISH— ALUMINUM CURTAIN, BOTTOM BAR, & GUIDES TO BE CLEAR ANODIZED.
- LOCKING— SLIDE BOLT TO ENGAGE GUIDE WITH PROVISION FOR PADLOCK. (PADLOCK BY OTHERS) QUANTITY REQUIRED
- LOCKING— FIVE PIN TUMBLER CYLINDER WITH LOCK BARS TO ENGAGE THE GUIDE. QUANTITY REQUIRED
- LOCK—OPERABLE FROM INTERIOR ONLY.
- LOCK—OPERABLE FROM EXTERIOR ONLY.

DOOR NUMBER	QTY	OPENING		MODEL	GA.	"A"	"B"	"C"	"D"	"E"	"F"	"G"	"H"	"J"	MOUNT TYPE	OPER.	DRIVE	JAMB TYPE	GUIDE	JOB:	
		WIDTH	HEIGHT																		
																					DISTRIBUTOR:
																					CONTRACTOR:
																					ARCHITECT:
																					NR:2902571

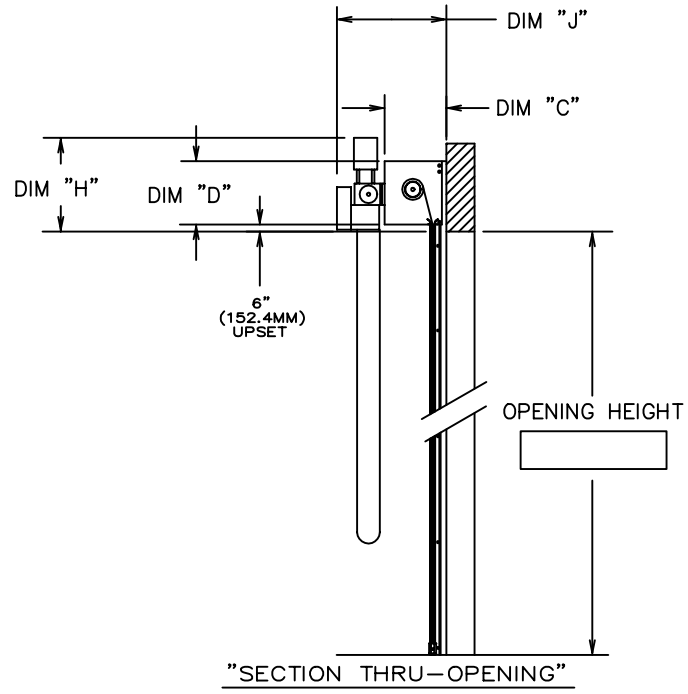

- RAYNOR POWERHOIST BASIC (PHBJR) 1/2 H.P., 115 VOLT, SINGLE PHASE
- RAYNOR POWERHOIST BASIC (PHBHR) 1/2 H.P., 115 VOLT, SINGLE PHASE
- RAYNOR POWERHOIST BASIC (PHBJ) 1/2 H.P., 115 VOLT, SINGLE PHASE
- RAYNOR POWERHOIST BASIC (PHBJH) 1/2 H.P., 115 VOLT, SINGLE PHASE
- RAYNOR POWERHOIST STANDARD (RBJ) ___ H.P., ___ VOLT, ___ PHASE
- RAYNOR POWERHOIST STANDARD (RBJH) ___ H.P., ___ VOLT, ___ PHASE
- RAYNOR POWERHOIST OPTIMA (RGJH) ___ H.P., ___ VOLT, ___ PHASE
- WIRING TYPE—SR2 WIRING, MOMENTARY CONTACT OPEN/CLOSE/STOP. SAFETY EDGE TO REVERSE.
- WIRING TYPE—SPECIAL (NOT AVAILABLE WITH PHBT OPERATORS) SPECIFY SPECIAL WIRING TYPE _____
- PNEUMATIC SAFETY EDGE TO REVERSE COIL CORD
- ELECTRIC SAFETY EDGE TO REVERSE CABLE TAKE UP REEL
- THRU—BEAM PHOTO EYES

ANSI/UL325 REQUIRES THE MOTOR OPERATOR BE MOUNTED A MINIMUM OF 8' ABOVE THE FLOOR OR GUARDING OF THE MOTOR OPERATOR TO PREVENT INJURY.(GUARDS BY OTHERS).

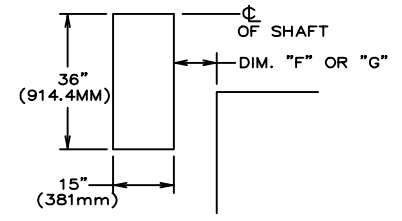

"OPERATOR MTG. PAD"
(FOR WALL MOUNTED OPERATORS ONLY)

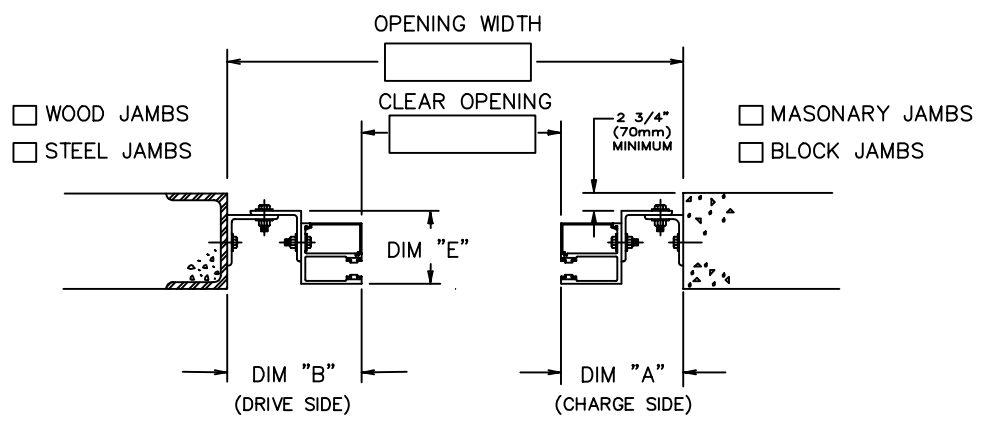

"GUIDE DETAIL"

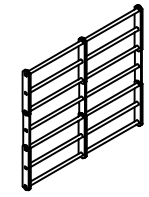

"GSA" STRAIGHT PATTERN

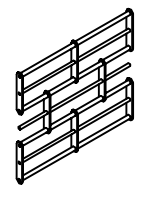

"GBA" BRICK PATTERN