

DOOR NUMBER	QTY	OPENING		MODEL	GA.	"A"	"B"	"C"	"D"	"E"	"F"	"G"	"H"	"J"	MOUNT TYPE	OPER.	DRIVE	JAMB TYPE	GUIDE	JOB:	DISTRIBUTOR:	CONTRACTOR:	ARCHITECT:	
		WIDTH	HEIGHT																					



NR:2904125

DURACOIL BASIC MODEL LFF  
BETWEEN JAMB MOUNT ABOVE LINTEL  
CRANK OPERATION

# DURACOIL

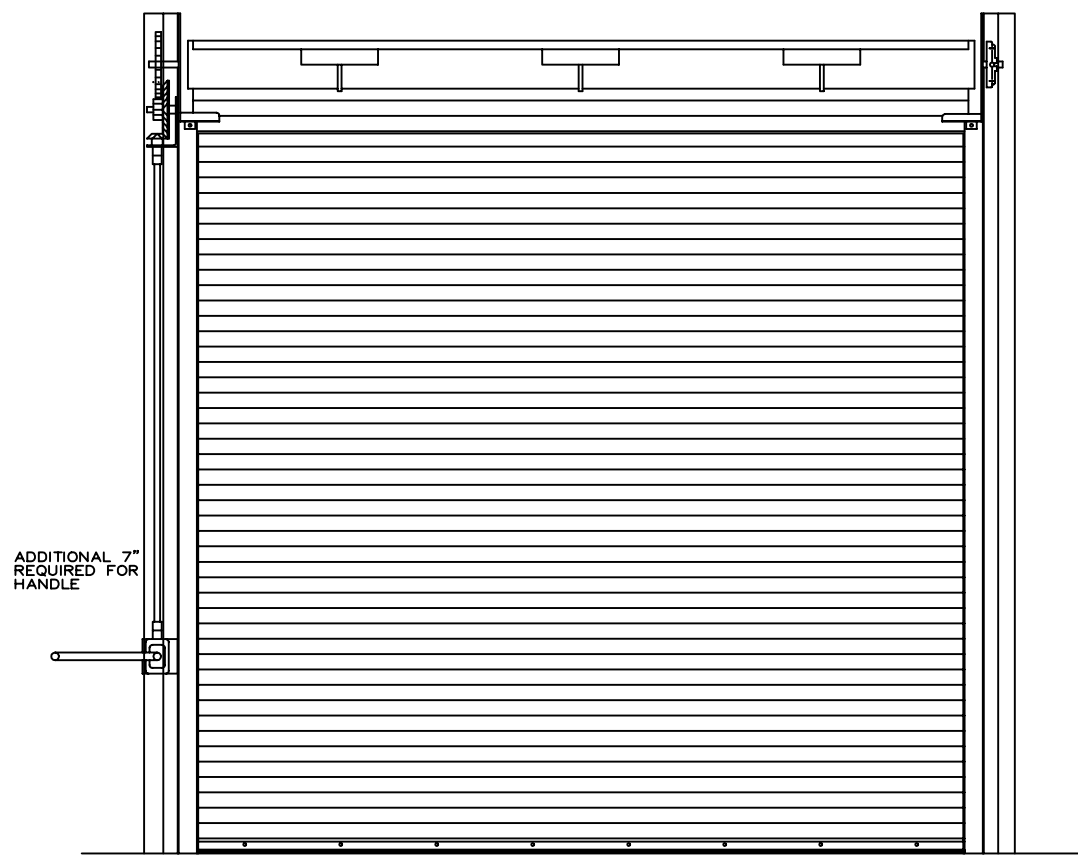

ADDITIONAL 7"  
REQUIRED FOR  
HANDLE

LEFT HAND DRIVE (SHOWN)      "ELEVATION"       RIGHT HAND DRIVE

DOORS SHALL BE ROLLING STEEL MODEL DURACOIL "BASIC" (STANDARD SERVICE DOOR) AS MANUFACTURED BY RAYNOR GARAGE DOORS.

BRACKETS- STEEL PLATES, MINIMUM 10 GA. GALVANIZED STEEL, ATTACHED WITH 1/2" (12.7MM) DIAMETER CLASS 5 CASE HARDENED BOLTS. THE INSIDE OF THE BRACKET IS FITTED WITH A SEALED BALL BEARING.

BARREL- STRUCTURAL STEEL PIPE, MINIMUM 4-1/2"(114.3mm) O.D.X.120" (3.0mm) WALL THICKNESS AND DESIGNED TO LIMIT MAXIMUM DEFLECTION, UNDER LOAD, TO .03 (0.76mm) PER FOOT OF SPAN.

SPRING COUNTERBALANCE- THE CURTAIN SHALL BE COUNTERBALANCED BY MEANS OF OIL TEMPERED, HELICAL TORSION SPRINGS, GREASE PACKED AND MOUNTED ON A SINGLE CONTINUOUS STEEL TORSION SHAFT. SPRINGS SHALL BE COMPRESSION SPRING DESIGN TO FACILITATE ANY COUNTERBALANCE MAINTENANCE. CAST IRON SPRING ANCHORS SHALL TRANSFER FULL SPRING LOADING TO THE BARREL.

HOOD- SHALL BE 24 GA. COMMERCIAL QUALITY HOT-DIPPED GALVANIZED STEEL. HOOD TO HAVE ROLLED EDGES TO PROVIDE RIGIDITY.

GUIDES- FORMED FROM A 16 GA., GALVANIZED CHANNEL FASTENED TO A MINIMUM 2 1/2" (63.5MM) X 2 1/2" (63.5MM) 11 GA. GALVANIZED STEEL WALL ANGLE.

### MODEL LFF

CURTAIN- INTERLOCKING SLATS ROLLFORMED FROM COMMERCIAL QUALITY HOT DIPPED GALVANIZED (G-80) STEEL PER ASTM A-653. FINISH SHALL BE A TWO COAT BAKED ON PRIME PAINT APPLIED PRIOR TO ROLLFORMING. MALLEABLE IRON GALVANIZED ENDLOCKS FASTENED TO ALTERNATE SLATS WITH TWO ZINC PLATED STEEL RIVETS PER LOCK, ELIMINATES LATERAL MOVEMENT AND PREVENT SLATS FROM WEARING AT SURFACES COMING IN CONTACT WITH GUIDES. BOTTOM OF CURTAIN SHALL BE REINFORCED WITH AN EXTRUDED T-SHAPED BAR. BOTTOM BAR SHALL BE PROVIDED WITH A U-SHAPED ASTRAGAL WEATHERSEAL.

CRANK- BY MEANS OF GRAY IRON REDUCTION GEARS AND 5/8" (15.9mm) SQUARE SHAFT DOWN TO A GEAR BOX WITH HANDLE. MAXIMUM PULL 35 POUNDS. (PADLOCK BY OTHERS.)

- HOOD-OMIT
- HOOD-SHALL BE 24 GA. COMMERCIAL QUALITY HOT-DIPPED GALVANIZED STEEL WITH ROLLED EDGES TO PROVIDE STRUCTURAL RIGIDTY.
- LOCKING- SLIDE BOLT TO ENGAGE GUIDE WITH PROVISION FOR PADLOCK. (PADLOCK BY OTHERS)  QUANTITY REQUIRED
- LOCKING- FIVE PIN TUMBLER CYLINDER WITH LOCK BARS TO ENGAGE THE GUIDE. QUANTITY REQUIRED
- LOCK-OPERABLE FROM INTERIOIR ONLY.
- LOCK-OPERABLE FROM EXTERIOIR ONLY.

DOOR NUMBER	QTY	OPENING		MODEL	GA.	"A"	"B"	"C"	"D"	"E"	"F"	"G"	"H"	"J"	MOUNT TYPE	OPER.	DRIVE	JAMB TYPE	GUIDE	JOB:	
		WIDTH	HEIGHT																		
																				DISTRIBUTOR:	<b>RAYNOR</b>
																				CONTRACTOR:	
																				ARCHITECT:	

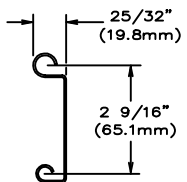

SLAT MODEL "LFF"

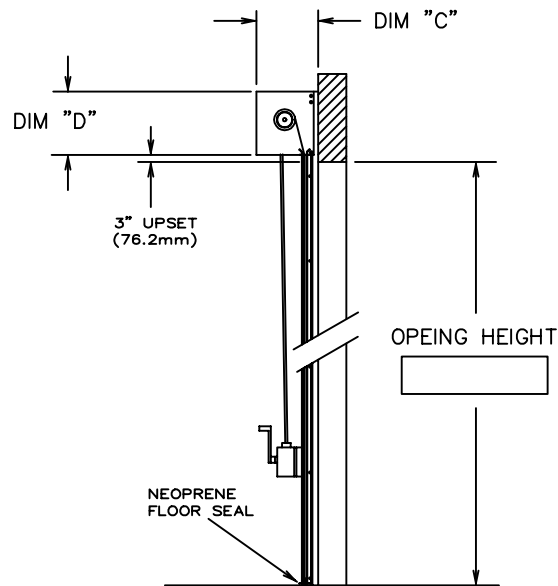

"SECTION THRU-OPENING"

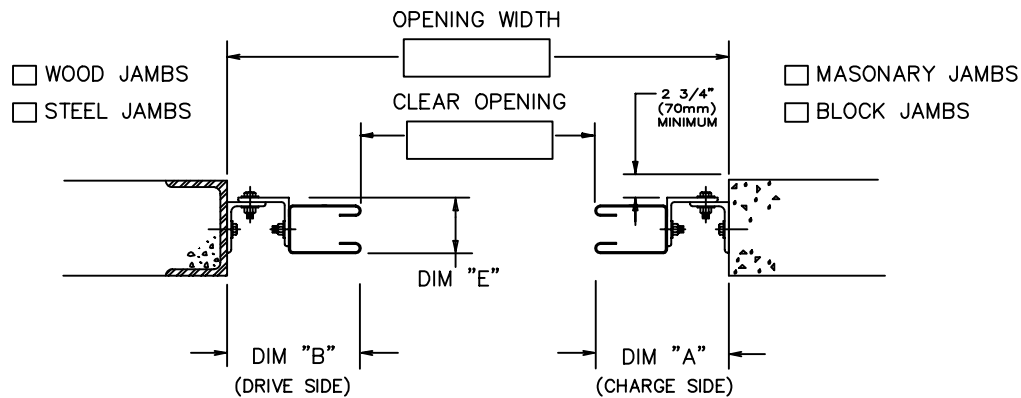

"GUIDE DETAIL"

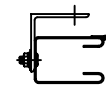

"GUIDE VINYL SEAL"

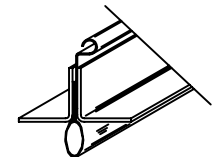

"NEOPRENE FLOOR SEAL"

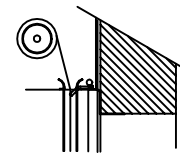

"LINTEL BRUSH SEAL"

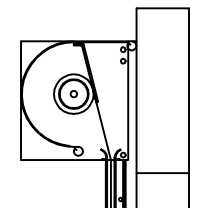

"RUBBER HOOD BAFFLE"

