

DOOR NUMBER	QTY	OPENING		MODEL	GA.	"A"	"B"	"C"	"D"	"E"	"F"	"G"	"H"	"J"	MOUNT TYPE	OPER.	DRIVE	JAMB TYPE	GUIDE	JOB:	
		WIDTH	HEIGHT																		
																				DISTRIBUTOR:	RAYNOR
																				CONTRACTOR:	
																				ARCHITECT:	NR:2901892

DURACOIL MODEL AF/AI/AP
 INTERIOR FACE MOUNT UNDER LINTEL
 HAND CHAIN OPERATION

DURACOIL

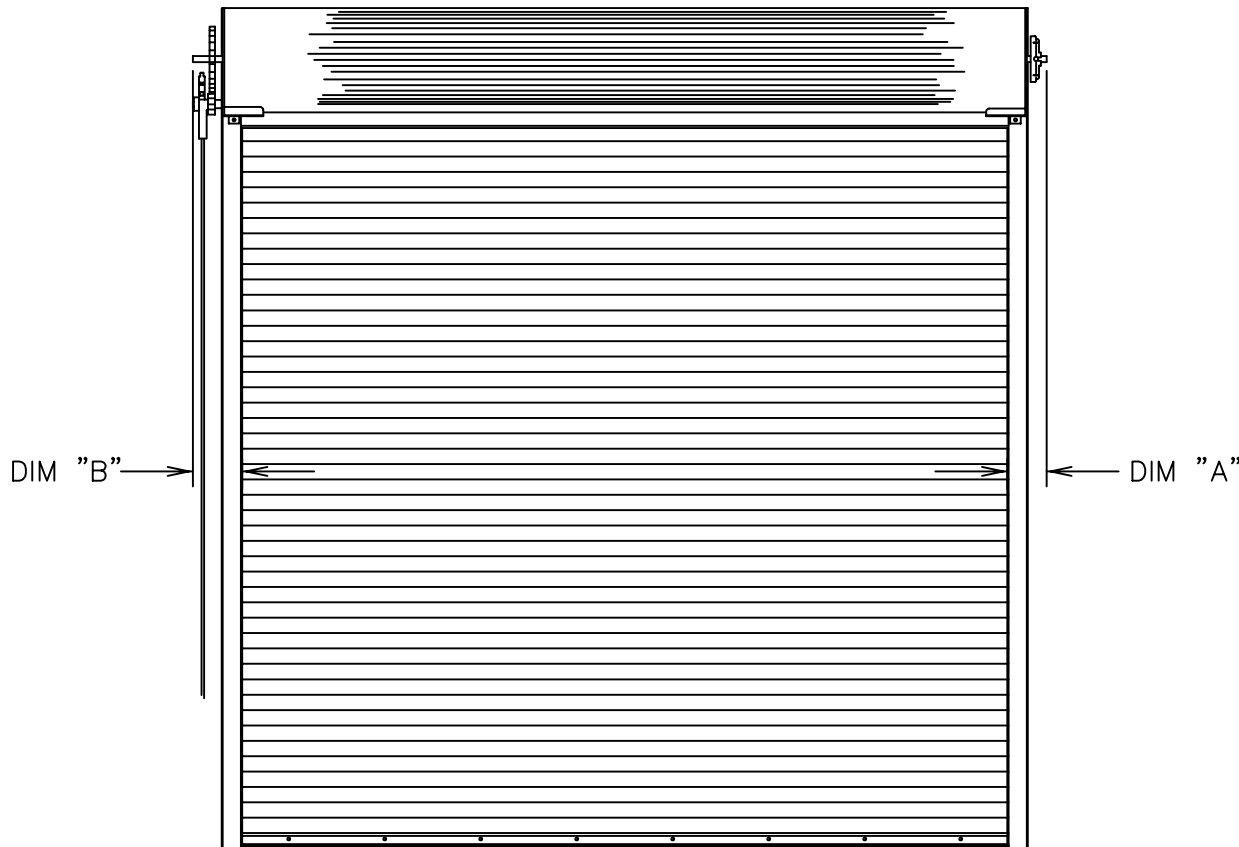

LEFT HAND DRIVE
 (SHOWN)

"ELEVATION"

RIGHT HAND DRIVE

DOORS SHALL BE ROLLING STEEL MODEL DURACOIL "STANDARD" (STANDARD SERVICE DOOR) AS MANUFACTURED BY RAYNOR GARAGE DOORS.

BRACKETS- STEEL PLATES, MIN. 3/16"(4.8mm) THICK, BOLTED TO GUIDES FOR MOUNTING CURTAIN AND BARREL ASSEMBLY. DRIVE SIDE BRACKET SHALL BE FITTED WITH A SEALED BALL BEARING FOR LONG LIFE.

BARREL- STRUCTURAL STEEL PIPE, MINIMUM 4-1/2"(114.3mm) O.D.X.120" (3.0mm) WALL THICKNESS AND DESIGNED TO LIMIT MAXIMUM DEFLECTION, UNDER LOAD, TO .03"(0.76mm) PER FOOT OF SPAN.

SPRING COUNTERBALANCE- THE CURTAIN SHALL BE COUNTERBALANCED BY MEANS OF OIL TEMPERED, HELICAL TORSION SPRINGS, GREASE- PACKED AND MOUNTED ON A SINGLE CONTINUOUS STEEL TORSION SHAFT. SPRINGS SHALL BE COMPRESSION SPRING DESIGN TO FACILITATE ANY COUNTERBALANCE MAINTENANCE. CAST IRON SPRING ANCHORS SHALL TRANSFER FULL SPRING LOADING TO THE BARREL.

HOOD- SHALL BE 24 GA. COMMERCIAL QUALITY HOT-DIPPED GALVANIZED STEEL. HOOD TO HAVE ROLLED EDGES TO PROVIDE RIGIDITY.

GUIDES- STRUCTURAL STEEL ANGLES, MIN. 3/16"(4.8mm) THICK. TOP OF GUIDE ANGLES FLARED AND PROVIDED WITH 4 REMOVABLE CURTAIN STOPS.

WINDLOAD- 20 LB./SQ. FT. STANDARD. UNLESS OTHERWISE NOTED.

CHAIN HOIST- BY MEANS OF GRAY IRON REDUCTION GEARS AND GALVANIZED HAND CHAIN. MAXIMUM PULL TO BE 35 POUNDS. LOCKING TO BE ACCOMPLISHED WITH HAND CHAIN LOCK. (PADLOCK BY OTHERS.)

MODEL AF

CURTAIN- INTERLOCKING SLATS ROLLFORMED FROM ALUMINUM 5005H34, ETCHED AND CLEAR ANODIZED 204R1 ON BOTH SIDES. MALLEABLE IRON GALVANIZED ENDLOCKS FASTENED TO ALTERNATE SLATS WITH TWO ZINC PLATED RIVETS PER LOCK, ELIMINATES LATERAL MOVEMENT AND PREVENT SLATS FROM WEARING AT SURFACES COMING IN CONTACT WITH GUIDES. BOTTOM OF CURTAIN SHALL BE REINFORCED WITH TWO ALUMINUM ANGLES, MIN. 2"X2"X3/16"(50.8mmX50.8mmX4.8mm). SINGLE CONTACT ASTRAGAL.

MODEL AI

CURTAIN -INSULATED- INTERLOCKING SLATS ROLLFORMED FROM ALUMINUM 5005H34 ETCH AND CLEAR ANODIZED ON BOTH SIDES TO 201R1. EACH SLAT SHALL HAVE A 3/4" (19.1mm) THICK POLYISO FOAMBOARD CORE PLACED WITHIN THE FULL LENGTH OF THE SLAT. BACKING COVER TO BE ALUMINUM EXTRUDED .02" THICK. MALLEABLE IRON GALVANIZED ENDLOCKS FASTENED TO ALTERNATE SLATS WITH 2 ZINC PLATED STEEL RIVETS PER ENDLOCK. ELIMINATES LATERAL MOVEMENT AND PREVENTS THE SLATS FROM WEARING AT SURFACES COMING IN CONTACT WITH GUIDES. BOTTOM OF CURTAIN SHALL BE REINFORCED WITH AN ALUMINUM EXTRUDED T-SHAPED BOTTOM BAR. SINGLE CONTACT ASTRAGAL. THE CURTAIN "U" VALUE IS .16 AND "R" VALUE IS 6.24. (SPECIFICATIONS REFLECT CALCULATED CHARACTERISTICS OF CORE MATERIAL).

MODEL AP

CURTAIN- SHALL CONSIST OF INTERLOCKING FLAT SLATS ROLL FORMED FROM NOT LESS THAN .04" (1.0mm) THICK ALUMINUM AND PUNCHED WITH A SERIES OF HOLES ACROSS THEIR ENTIRE LENGTH, PROVIDING 31% OPEN AREA PER SQUARE FOOT OF DOOR. BOTTOM OF CURTAIN SHALL BE REINFORCED WITH TWO ALUMINUM ANGLES, MINIMUM 2"X2"X3/16" (50.8mmX50.8mmX4.8mm). SINGLE CONTACT BOTTOM ASTRAGAL.

LOCKING- SLIDE BOLT TO ENGAGE GUIDE WITH PROVISION FOR PADLOCK. (PADLOCK BY OTHERS) QUANTITY REQUIRED

LOCKING- FIVE PIN TUMBLER CYLINDER WITH LOCK BARS TO ENGAGE THE GUIDE. QUANTITY REQUIRED

LOCK-OPERABLE FROM INTERIOR ONLY.

LOCK-OPERABLE FROM EXTERIOR ONLY.

DOOR NUMBER	QTY	OPENING		MODEL	GA.	"A"	"B"	"C"	"D"	"E"	"F"	"G"	"H"	"J"	MOUNT TYPE	OPER.	DRIVE	JAMB TYPE	GUIDE	JOB:		
		WIDTH	HEIGHT																			
																					DISTRIBUTOR:	
																						CONTRACTOR:
																						ARCHITECT:
																					NR:2901892	

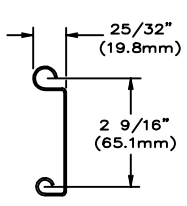

SLAT MODEL "AF"

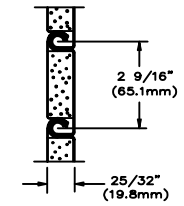

SLAT MODEL "AI"

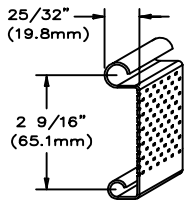

SLAT MODEL "AP"

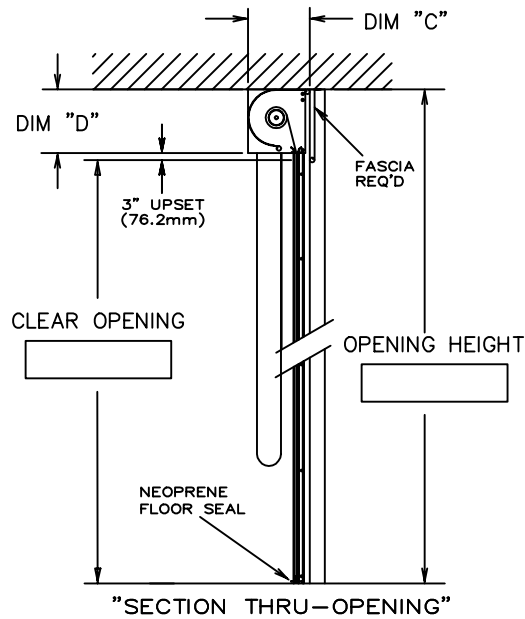

"SECTION THRU-OPENING"

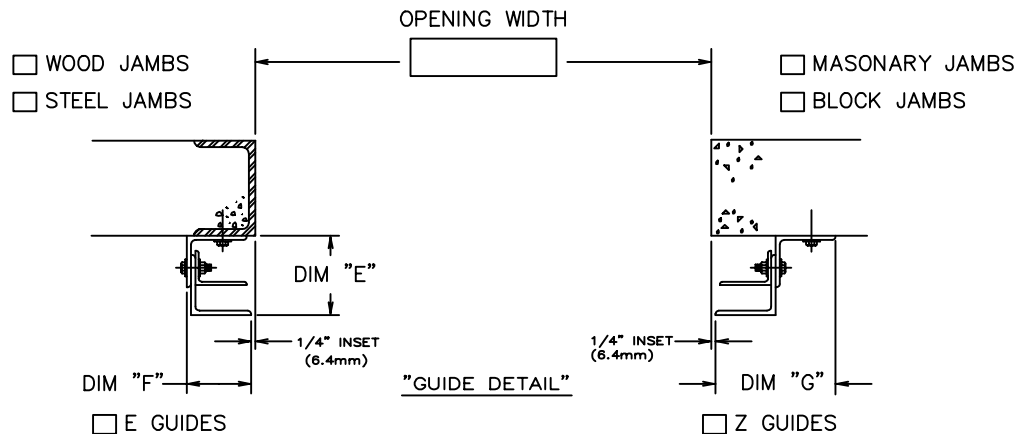

E GUIDES
(NOT AVAILABLE ON BLOCK OR MASONARY JAMBS)

Z GUIDES

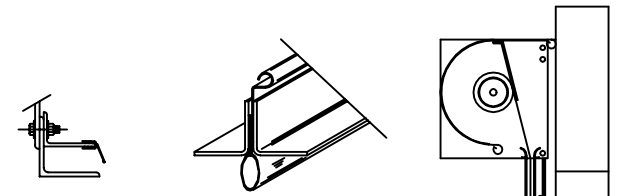

"GUIDE VINYL SEAL"

"NEOPRENE FLOOR SEAL"

"RUBBER HOOD BAFFLE"

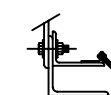

"GUIDE BRUSH SEAL"

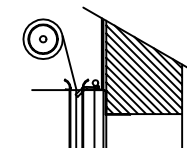

"LINTEL BRUSH SEAL"