

DOOR NUMBER	QTY	OPENING		MODEL	GA.	"A"	"B"	"C"	"D"	"E"	"F"	"G"	"H"	"J"	MOUNT TYPE	OPER.	DRIVE	JAMB TYPE	GUIDE	JOB:	DISTRIBUTOR:	CONTRACTOR:	ARCHITECT:	
		WIDTH	HEIGHT																					



NR:2901870

DURACOIL MODEL FF/SC/LC/IF/FP
INTERIOR FACE MOUNT MOTOR OPERATION.

DURACOIL

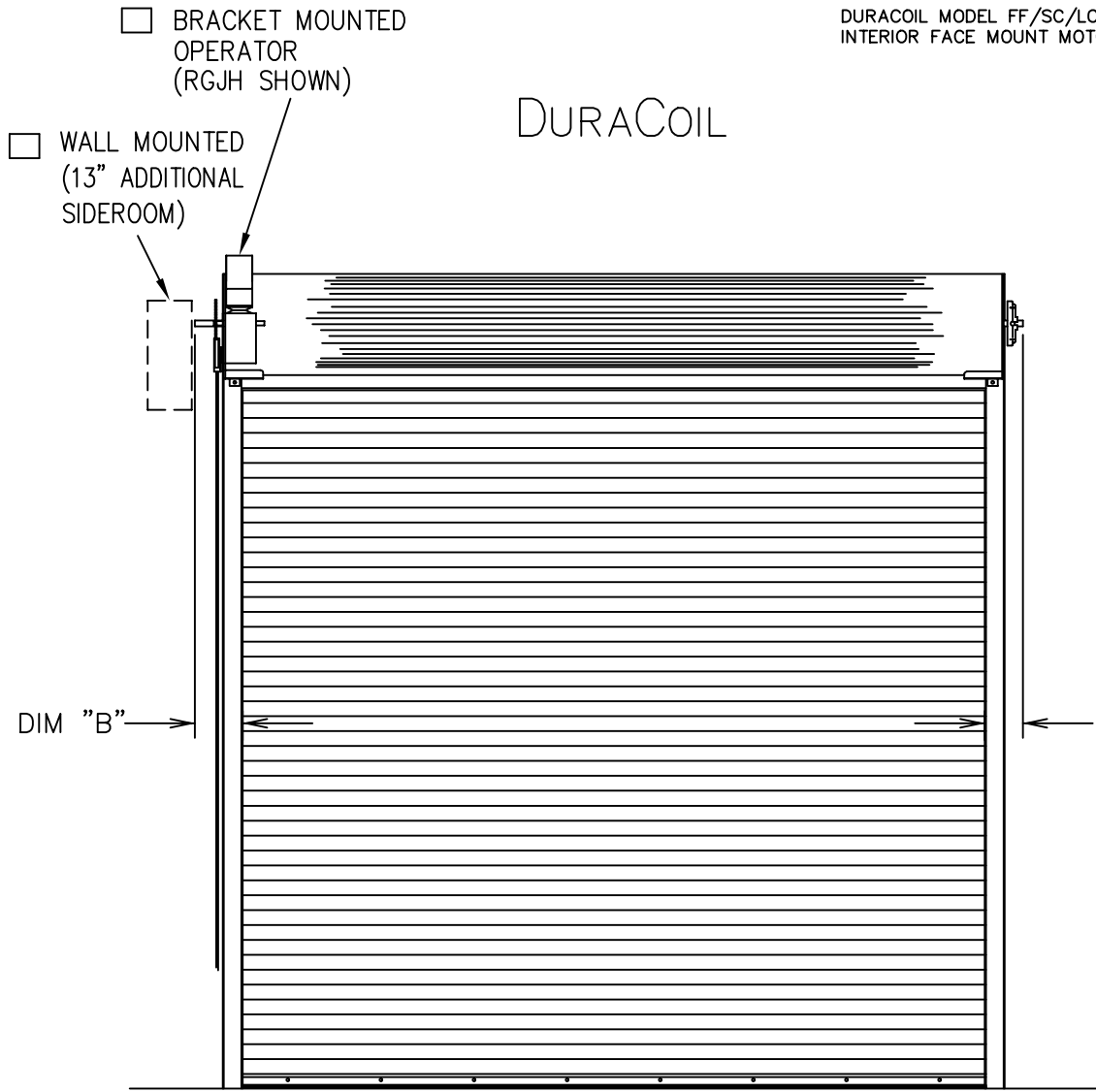

DOORS SHALL BE ROLLING STEEL MODEL DURACOIL "STANDARD" (STANDARD SERVICE DOOR) AS MANUFACTURED BY RAYNOR GARAGE DOORS.

BRACKETS- STEEL PLATES, MIN. 3/16"(4.8mm) THICK, BOLTED TO GUIDES FOR MOUNTING CURTAIN AND BARREL ASSEMBLY. DRIVE SIDE BRACKET SHALL BE FITTED WITH A SEALED BALL BEARING FOR LONG LIFE.

BARREL- STRUCTURAL STEEL PIPE, MINIMUM 4-1/2"(114.3mm) O.D.X.120" (3.0mm) WALL THICKNESS AND DESIGNED TO LIMIT MAXIMUM DEFLECTION, UNDER LOAD, TO .03"(0.76mm) PER FOOT OF SPAN.

SPRING COUNTERBALANCE- THE CURTAIN SHALL BE COUNTERBALANCED BY MEANS OF OIL TEMPERED, HELICAL TORSION SPRINGS, GREASE-PACKED AND MOUNTED ON A SINGLE CONTINUOUS STEEL TORSION SHAFT. SPRINGS SHALL BE COMPRESSION SPRING DESIGN TO FACILITATE ANY COUNTERBALANCE MAINTENANCE. CAST IRON SPRING ANCHORS SHALL TRANSFER FULL SPRING LOADING TO THE BARREL.

HOOD- SHALL BE 24 GA. COMMERCIAL QUALITY HOT-DIPPED GALVANIZED STEEL. HOOD TO HAVE ROLLED EDGES TO PROVIDE RIGIDITY.

GUIDES- STRUCTURAL STEEL ANGLES, MIN. 3/16"(4.8mm) THICK. TOP OF GUIDE ANGLES FLARED AND PROVIDED WITH 4 REMOVABLE CURTAIN STOPS.

WINDLOAD- 20 LB./SQ. FT. STANDARD. UNLESS OTHERWISE NOTED.

MODEL FF/SC/LC

CURTAIN- INTERLOCKING SLATS ROLLFORMED FROM COMMERCIAL QUALITY HOT DIPPED GALVANIZED (G-90) STEEL PER ASTM A-653. FINISH SHALL BE A TWO COAT BAKED ON PRIME PAINT APPLIED PRIOR TO ROLLFORMING. MALLEABLE IRON GALVANIZED ENDLOCKS FASTENED TO ALTERNATE SLATS WITH TWO ZINC PLATED STEEL RIVETS PER SLAT. ELIMINATES LATERAL MOVEMENT AND PREVENT SLATS FROM WEARING AT SURFACES COMING IN CONTACT WITH GUIDES. BOTTOM OF CURTAIN SHALL BE REINFORCED WITH TWO STEEL ANGLES, MINIMUM 2"x2"x3/16"(50.8mmX50.8mmX4.8mm). SINGLE CONTACT BOTTOM ASTRAGAL.

MODEL IF

CURTAIN -INSULATED- INTERLOCKING SLATS ROLLFORMED FROM COMMERCIAL QUALITY HOT DIPPED GALVANIZED (G-90) STEEL PER ASTM A-653. EACH SLAT SHALL HAVE A 3/4" (19.1mm) THICK, POLYSTYRENE FOAMBOARD CORE PLACE WITHIN THE FULL LENGTH OF THE SLAT. BACKING COVER TO BE A 24GA. HOT-DIPPED GALVANIZED STEEL. FINISH SHALL BE A TWO COAT BAKED ON PRIME PAINT APPLIED PRIOR TO ROLLFORMING. MALLEABLE IRON GALVANIZED ENDLOCKS FASTENED TO ALTERNATE SLATS WITH TWO ZINC PLATED STEEL RIVETS PER ENDLOCK. ELIMINATES LATERAL MOVEMENT AND PREVENTS THE SLATS FROM WEARING AT SURFACES COMING IN CONTACT WITH GUIDES. BOTTOM OF CURTAIN SHALL BE REINFORCED WITH TWO STEEL ANGLES, MINIMUM 2"x2"x3/16" (50.8mmX50.8mmX4.8mm). THE CURTAIN "U" VALUE IS .16 AND THE "R" VALUE IS 6.24 (SPECIFICATIONS REFLECT CALCULATED CHARACTERISTICS OF CORE MATL.).

MODEL FP

CURTAIN- SHALL CONSIST OF INTERLOCKING FLAT SLATS ROLLFORMED FROM NOT LESS THAN 22GA. COMMERCIAL QUALITY HOT DIPPED GALVANIZED (G-90) STEEL PER ASTM A-653. SLATS SHALL BE PUNCHED WITH A SERIES OF HOLES ACROSS THEIR ENTIRE LENGTH, PROVIDING 31% OPEN AREA PER SQUARE FOOT OF DOOR. BOTTOM OF CURTAIN SHALL BE REINFORCED WITH TWO STEEL ANGLES, MINIMUM 2"x2"x3/16" (50.8mmX50.8mmX4.8mm). SINGLE CONTACT BOTTOM ASTRAGAL.

- LOCKING- SLIDE BOLT TO ENGAGE GUIDE WITH PROVISION FOR PADLOCK. (PADLOCK BY OTHERS) QUANTITY REQUIRED
- LOCKING- FIVE PIN TUMBLER CYLINDER WITH LOCK BARS TO ENGAGE THE GUIDE. QUANTITY REQUIRED
- LOCK-OPERABLE FROM INTERIOIR ONLY.
- LOCK-OPERABLE FROM EXTERIOIR ONLY.

DOOR NUMBER	QTY	OPENING		MODEL	GA.	"A"	"B"	"C"	"D"	"E"	"F"	"G"	"H"	"J"	MOUNT TYPE	OPER.	DRIVE	JAMB TYPE	GUIDE	JOB:		
		WIDTH	HEIGHT																			
																					DISTRIBUTOR:	
																						CONTRACTOR:
																						ARCHITECT: NR:2901870

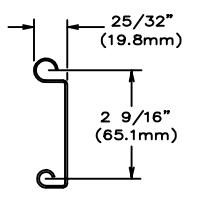

SLAT MODEL "FF"

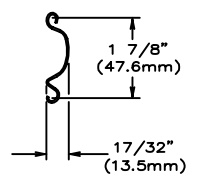

SLAT MODEL "SC"

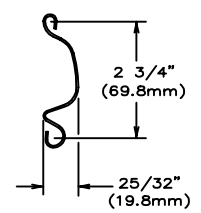

SLAT MODEL "LC"

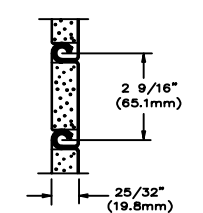

SLAT MODEL "IF"

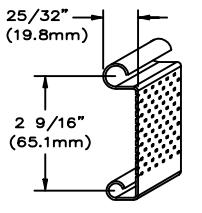

SLAT MODEL "FP"

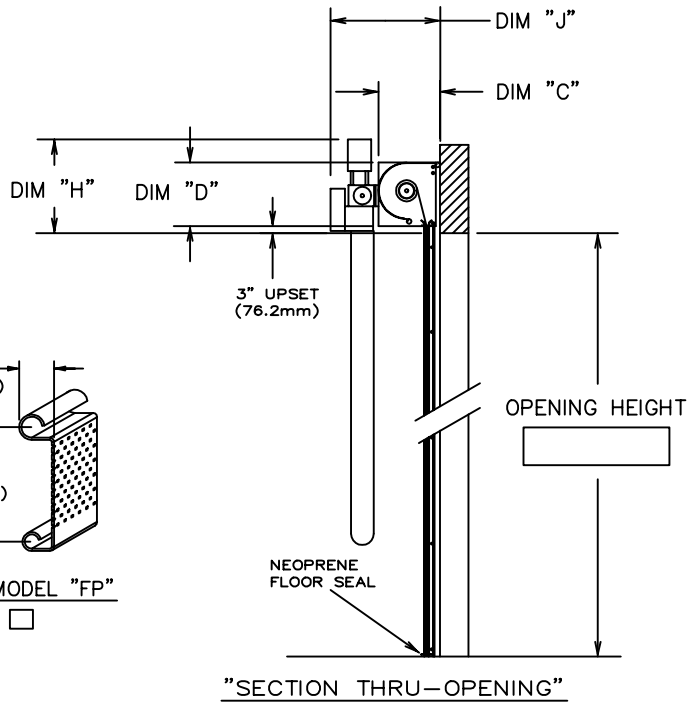

"SECTION THRU-OPENING"

- RAYNOR POWERHOIST BASIC (PHBJR) 1/2 H.P., 115 VOLT, SINGLE PHASE
- RAYNOR POWERHOIST BASIC (PHBHR) 1/2 H.P., 115 VOLT, SINGLE PHASE
- RAYNOR POWERHOIST BASIC (PHBJ) 1/2 H.P., 115 VOLT, SINGLE PHASE
- RAYNOR POWERHOIST BASIC (PHBJH) 1/2 H.P., 115 VOLT, SINGLE PHASE
- RAYNOR POWERHOIST STANDARD (RBJ) ___ H.P., ___ VOLT, ___ PHASE
- RAYNOR POWERHOIST STANDARD (RBJH) ___ H.P., ___ VOLT, ___ PHASE
- RAYNOR POWERHOIST OPTIMA (RGJH) ___ H.P., ___ VOLT, ___ PHASE
- WIRING TYPE-SR2 WIRING, MOMENTARY CONTACT OPEN/CLOSE/STOP. SAFETY EDGE TO REVERSE.
- WIRING TYPE-SPECIAL (NOT AVAILABLE WITH PHBT OPERATORS) SPECIFY SPECIAL WIRING TYPE _____
- PNEUMATIC SAFETY EDGE TO REVERSE COIL CORD
- ELECTRIC SAFETY EDGE TO REVERSE CABLE TAKE UP REEL
- THRU-BEAM PHOTO EYES

ANSI/UL325 REQUIRES THE MOTOR OPERATOR BE MOUNTED A MINIMUM OF 8' ABOVE THE FLOOR OR GUARDING OF THE MOTOR OPERATOR TO PREVENT INJURY.(GUARDS BY OTHERS).

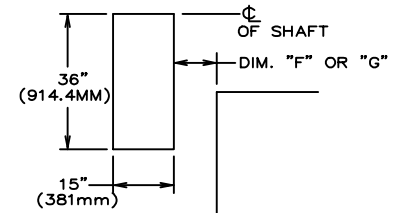

"OPERATOR MTG. PAD"
(FOR WALL MOUNTED OPERATORS ONLY)

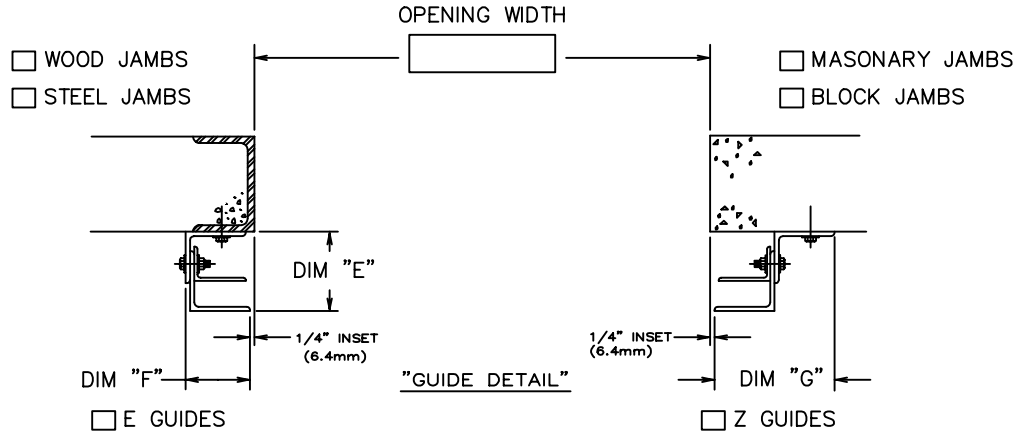

E GUIDES
(NOT AVAILABLE ON BLOCK OR MASONRY JAMBS)

Z GUIDES

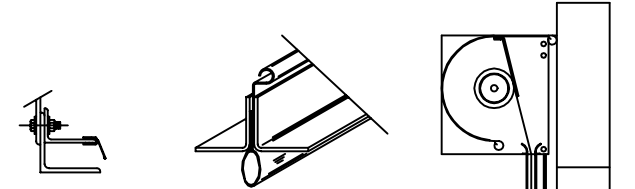

"GUIDE VINYL SEAL" "NEOPRENE FLOOR SEAL" "RUBBER HOOD BAFFLE"

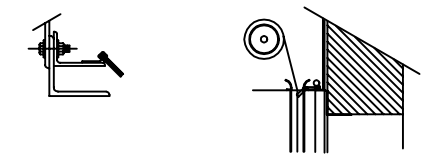

"GUIDE BRUSH SEAL" "LINTEL BRUSH SEAL"